











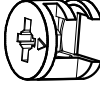
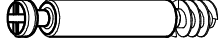



 Ø6,3x50 mm A1 x 57	 Ø12 mm A2 x 57	 4 mm A3 x 1	 Ø15x12 mm B1 x 14	 Ø5x44 mm B2 x 14
 Ø20 mm B3 x 14	 Ø12x3 mm C x 8	 Ø3x25 mm D1 x 14	 Ø4x16 mm D2 x 28	 Ø4x20 mm D3 x 8
 Ø3x16 mm D4 x 12	 Ø4x30 mm D5 x 5	 Ø1,6x25 mm F x 148	 Ø8x36 mm G x 19	 H1 x 1
 H2 x 1	 Ø5x16 mm L x 4	 M x 7	 Ø15 mm N x 12	 X x 2
 Z x 14				

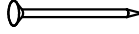

Box 1

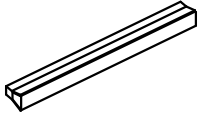
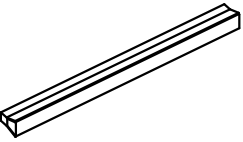
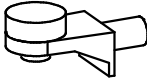
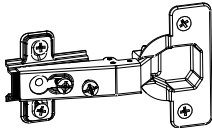
1819x334x16 mm

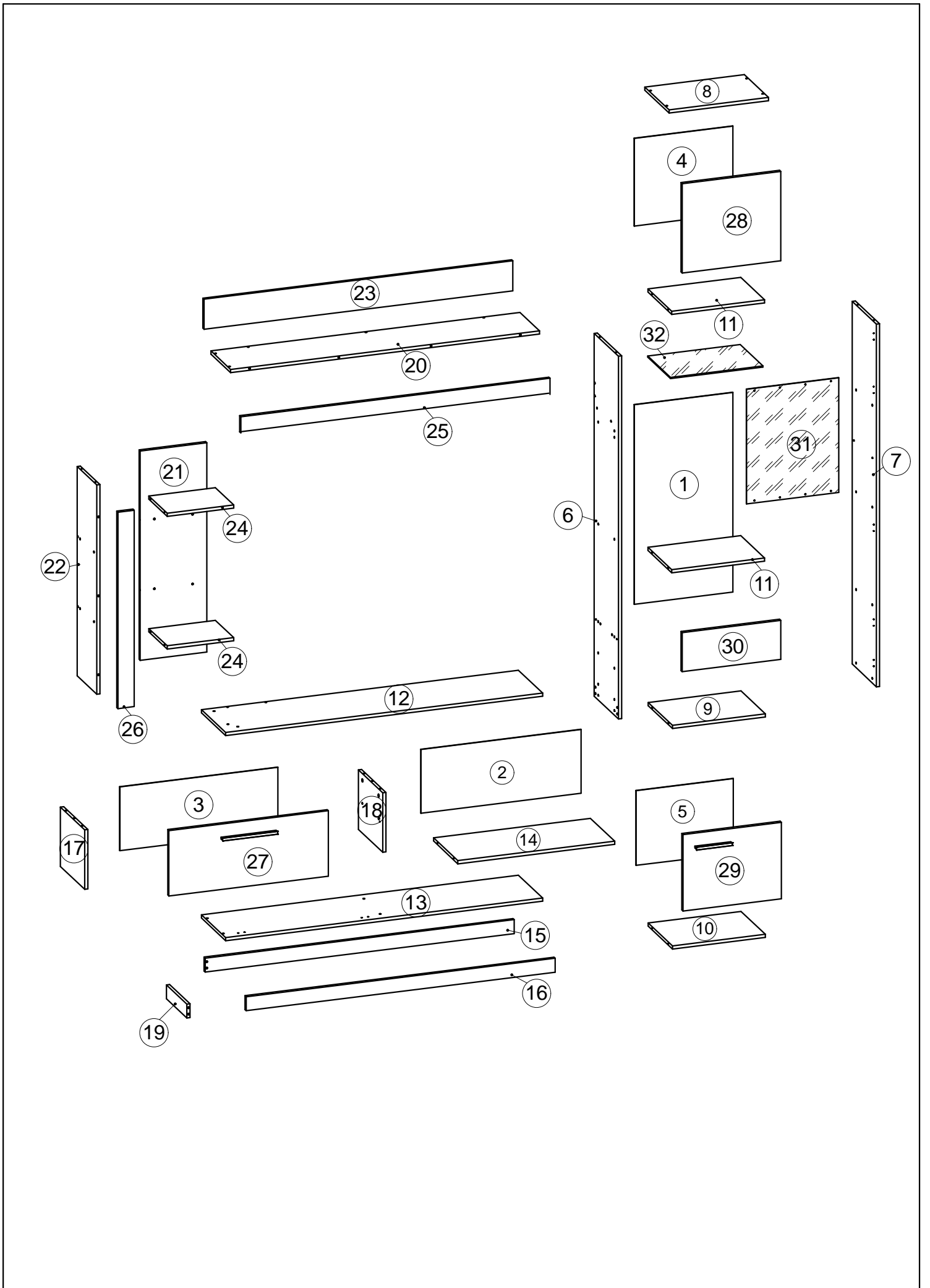
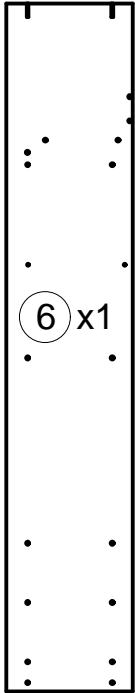

1819x334x16 mm

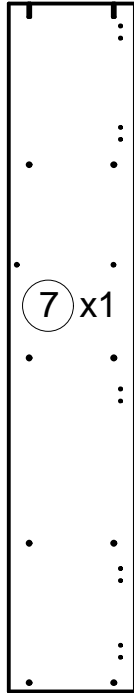

1549x150x16 mm

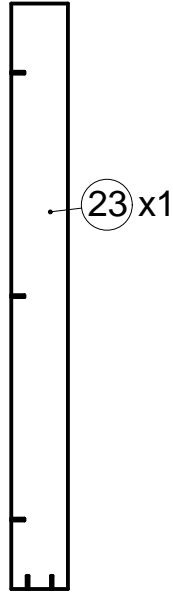

1550x80x16 mm

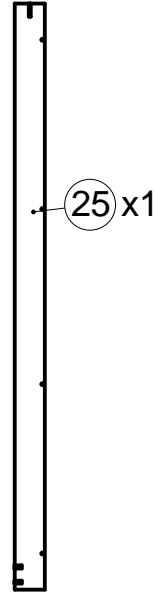

1550x270x16 mm

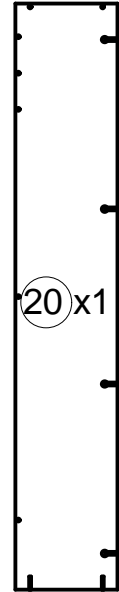

984x80x16 mm

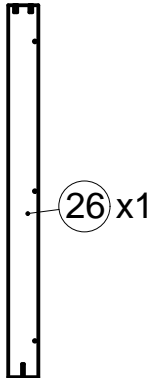

498x334x16 mm

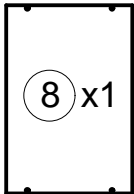

466x334x16 mm

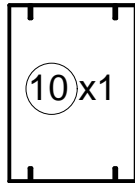

466x334x16 mm

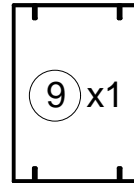

466x327x16 mm

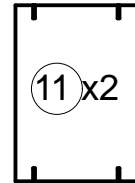

Fittings & Tools

Box 2

787x334x16 mm

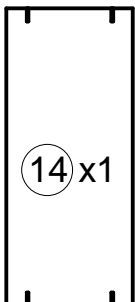

298x334x16 mm

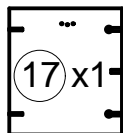

298x334x16 mm

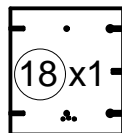

1050x334x16 mm

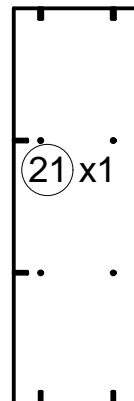

1050x270x16 mm

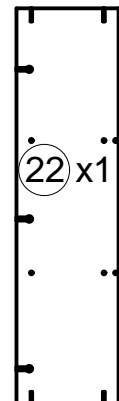

70x280x16 mm

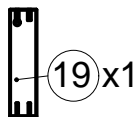

333x252x16 mm

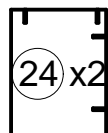

Box 2

1590x334x16 mm

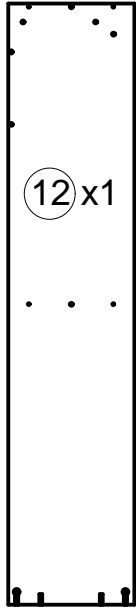

1590x334x16 mm

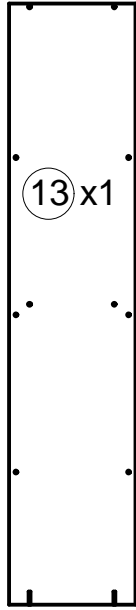

1550x70x16 mm

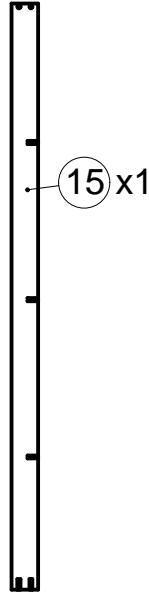

1550x70x16 mm

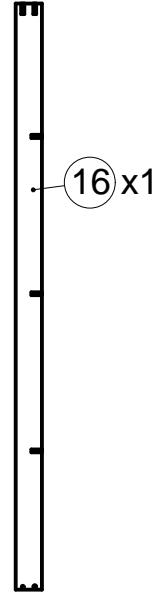

Box 3

799x327x16 mm

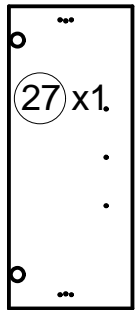

493x447x16 mm

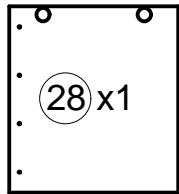

493x382x16 mm

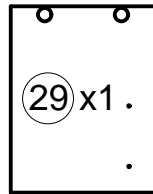

195x493x16 mm

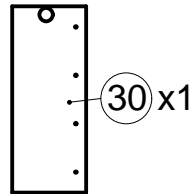

1001x494x3 mm

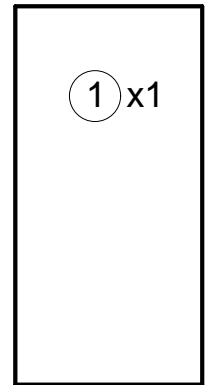

320x803x3 mm

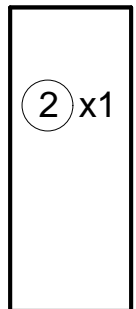

793x320x3 mm

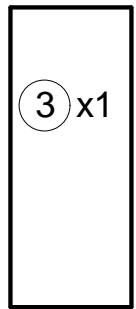

494x440x3 mm

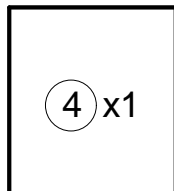

488x375x3 mm

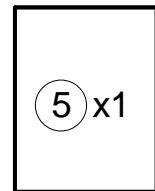

Box 4

575x462x4 mm

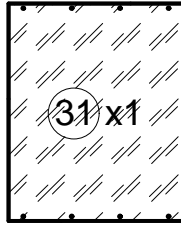

464x314x6 mm



1

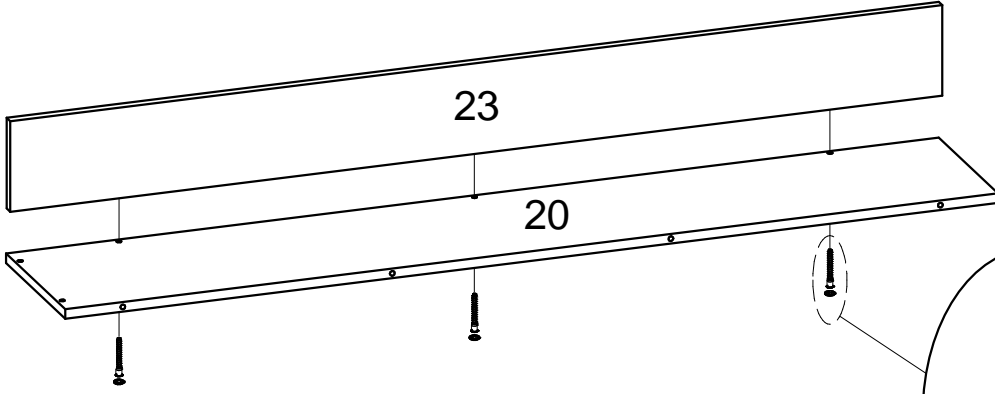
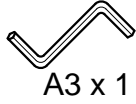
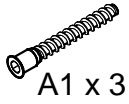

2

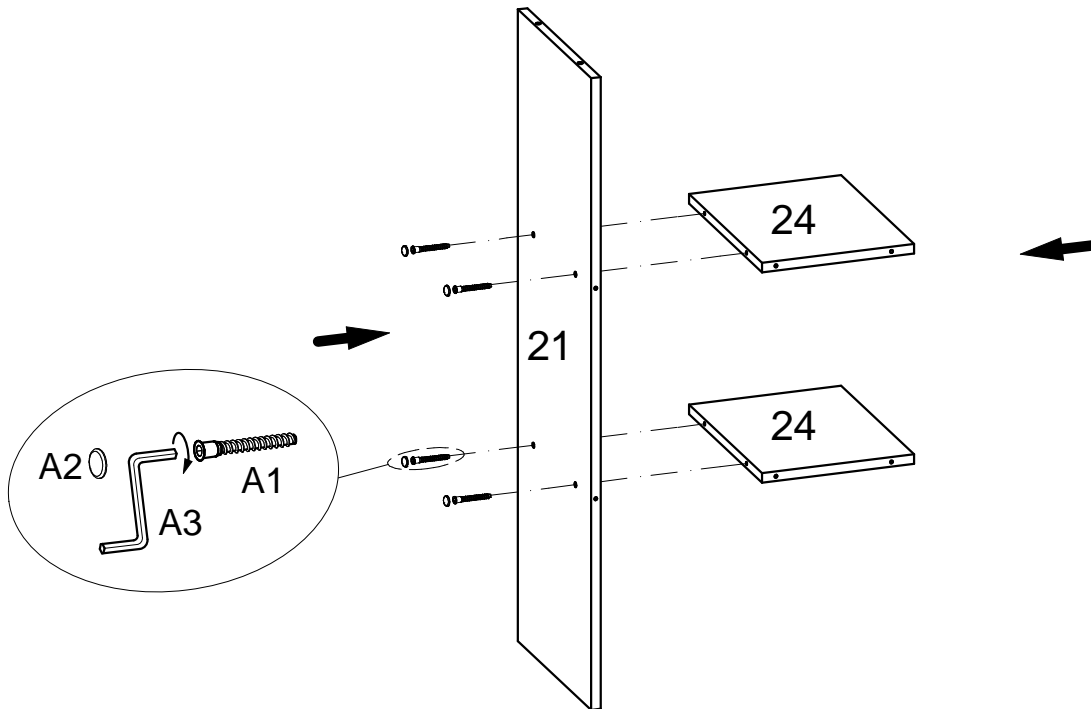
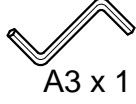
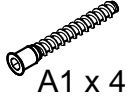

3

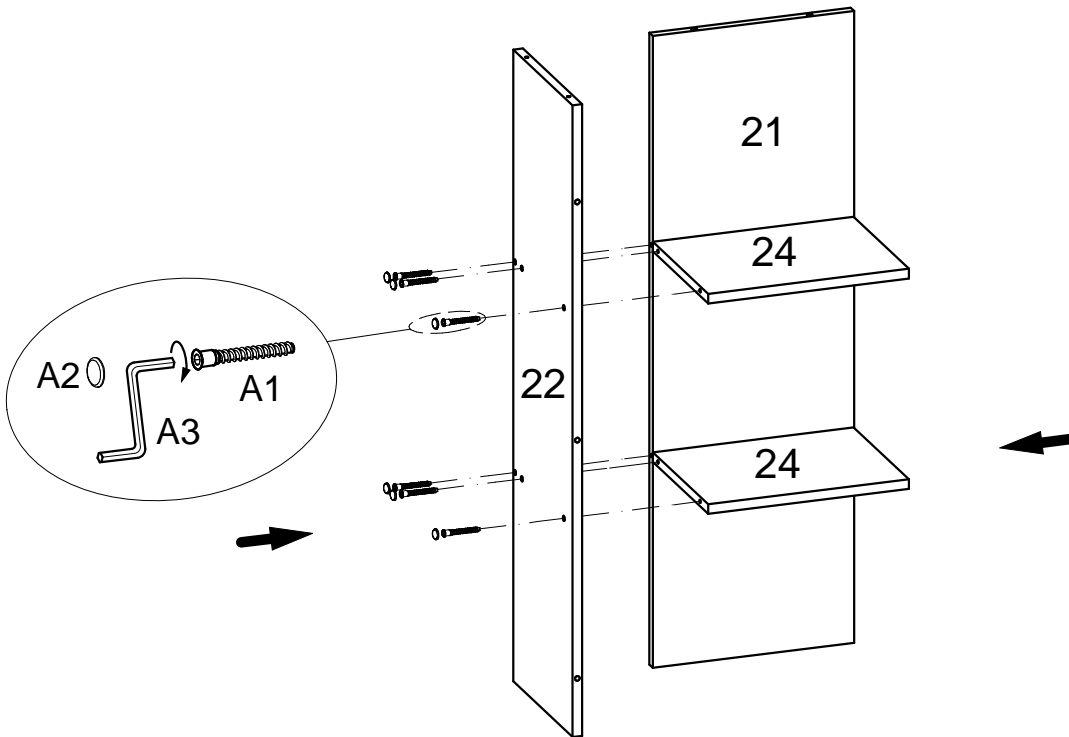
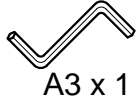
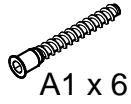

4

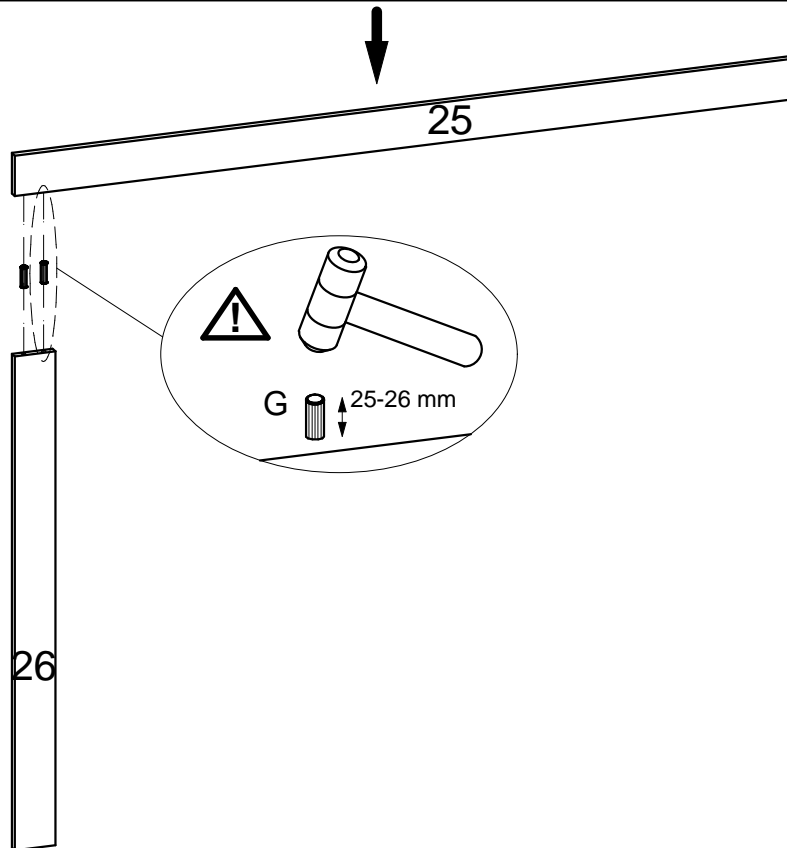
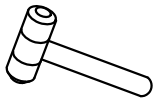

5



A1 x 16



A2 x 16

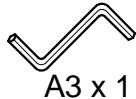

A3 x 1



N x 4

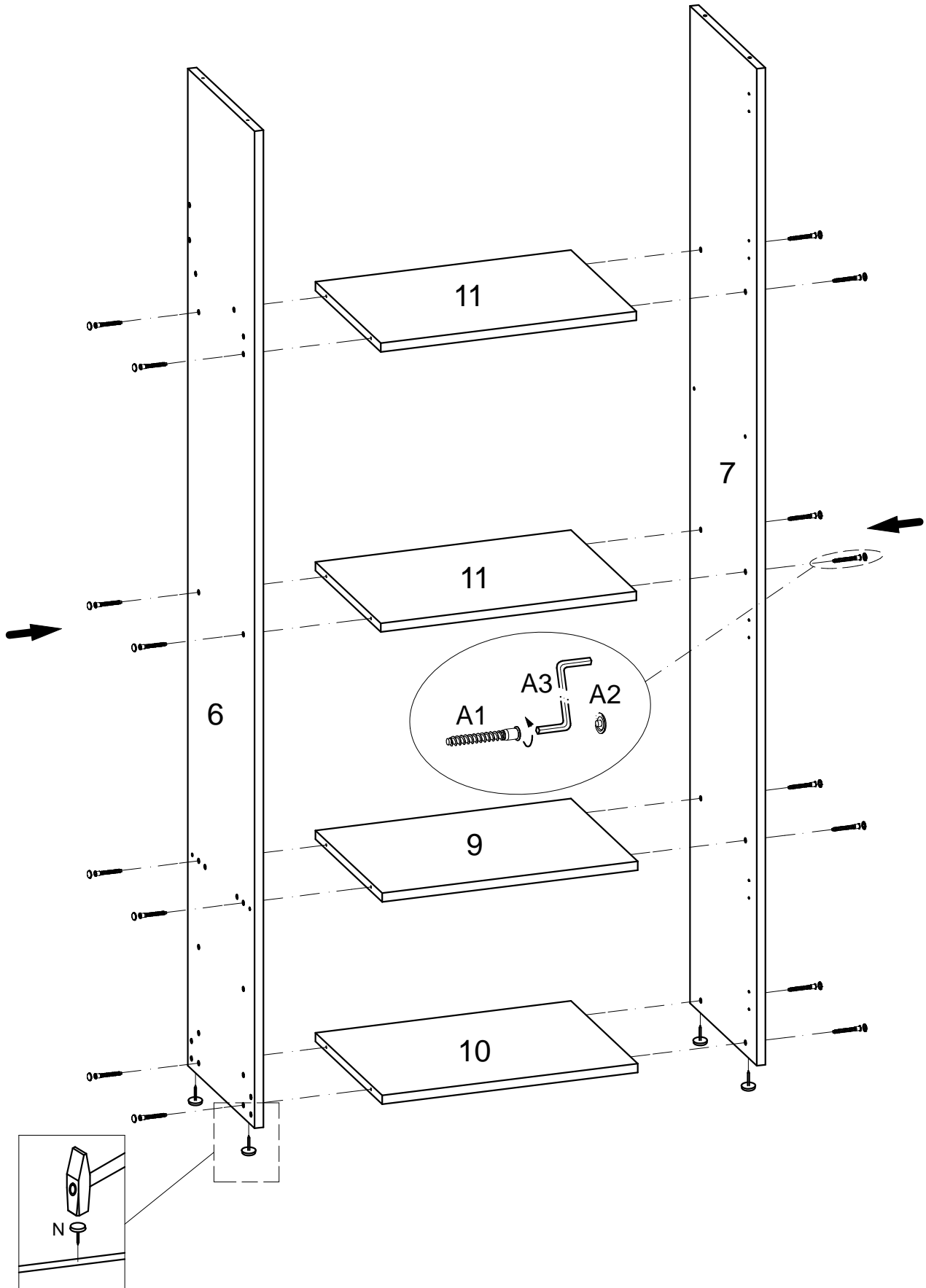
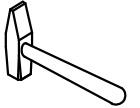

6

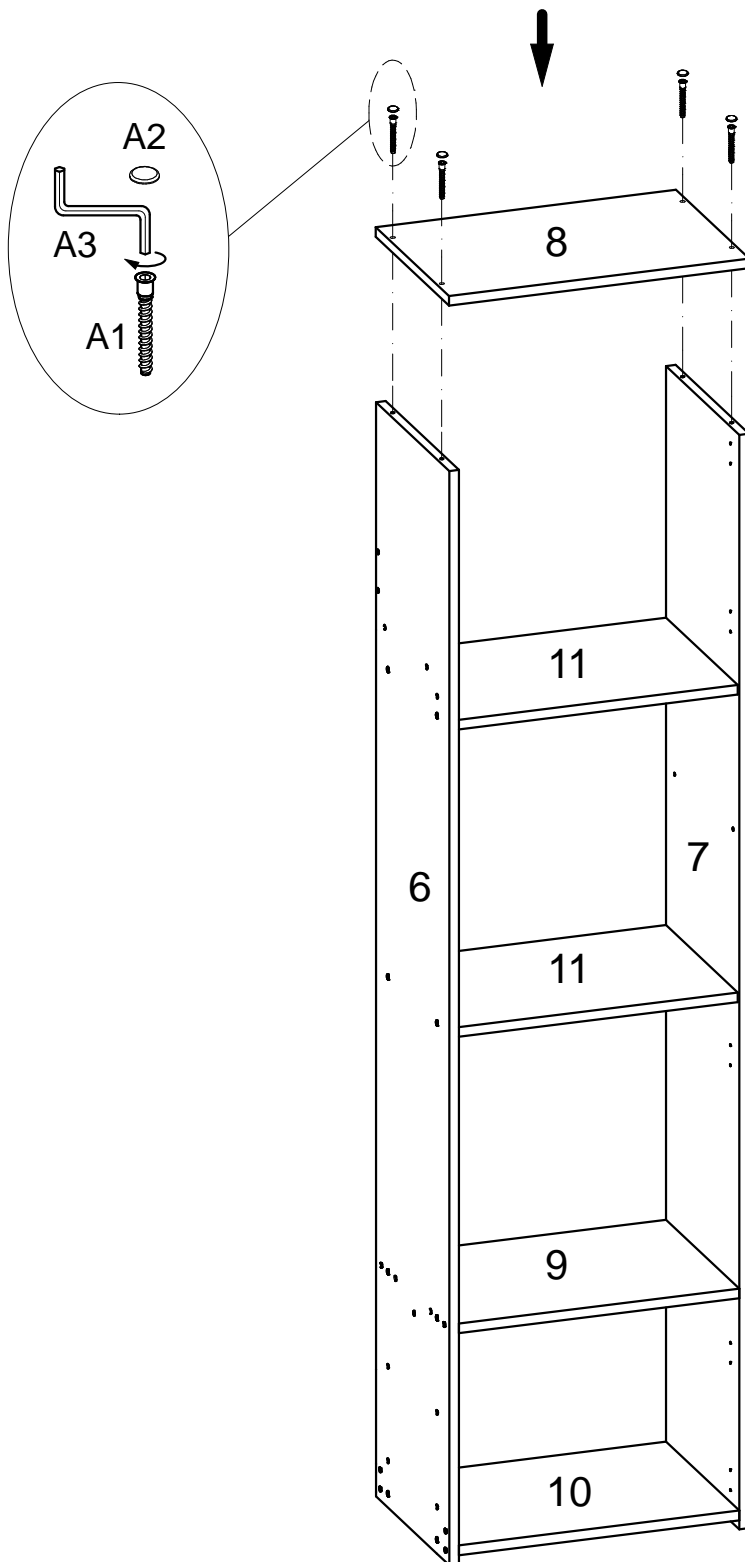
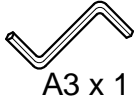
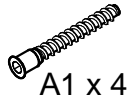

7

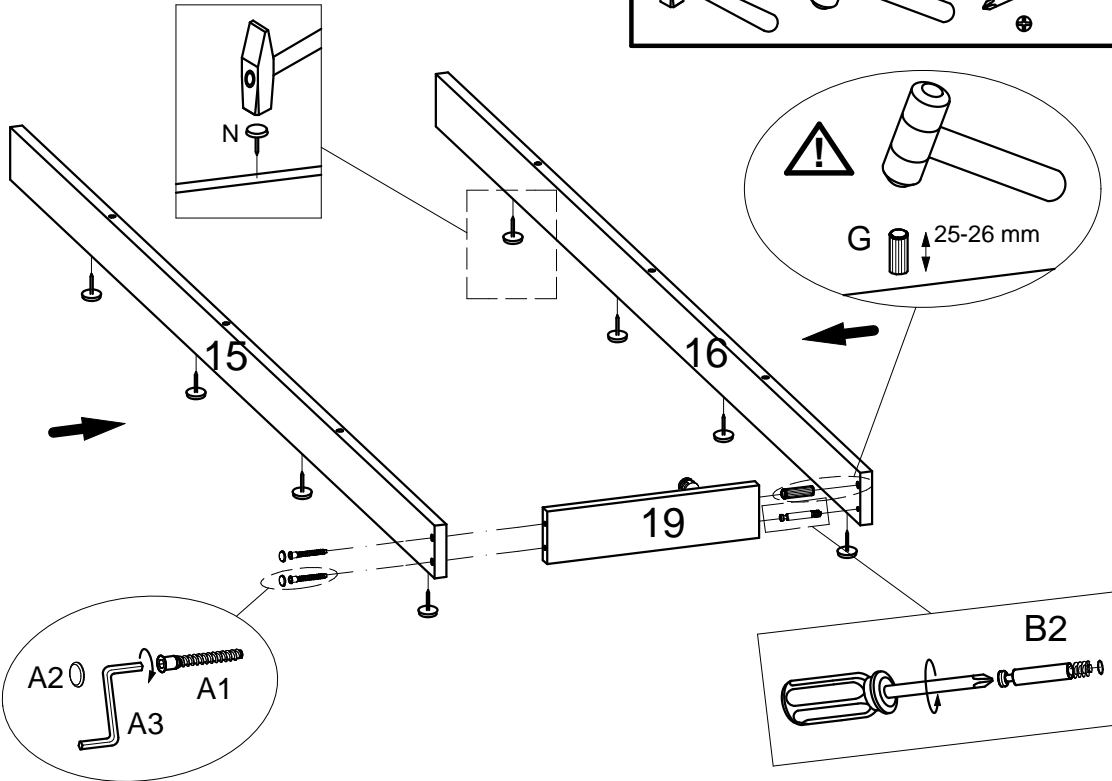
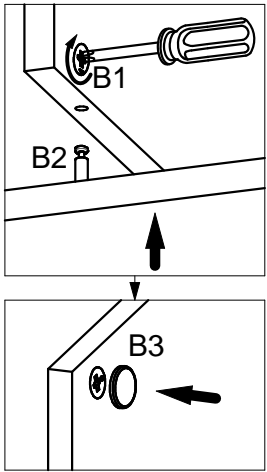
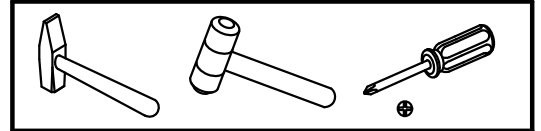
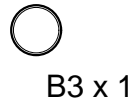
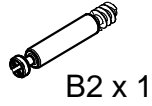
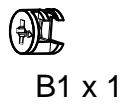
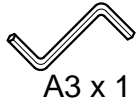
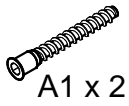

8

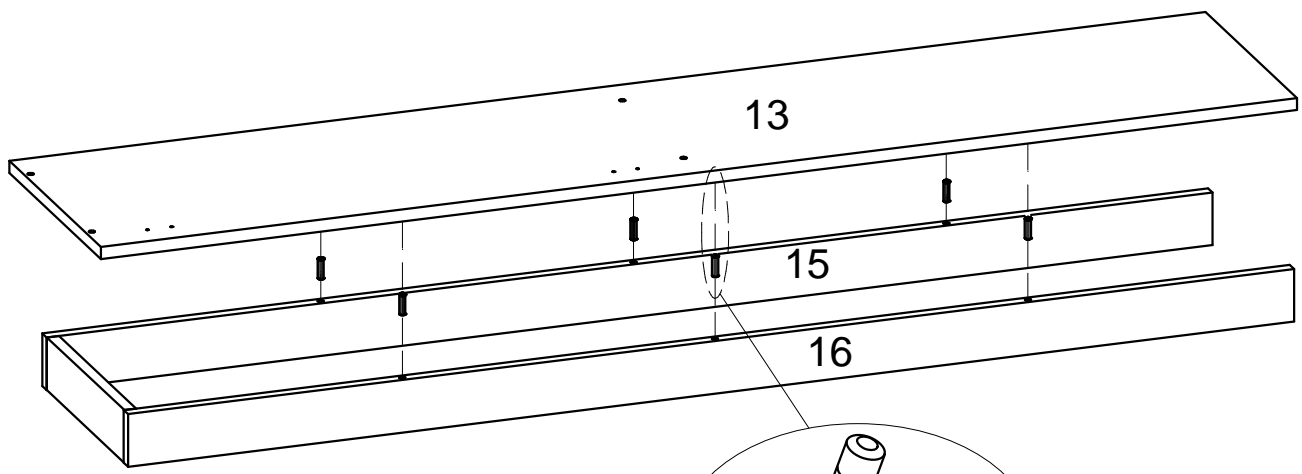
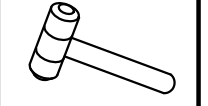

9



A1 x 4



A2 x 4

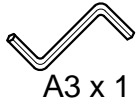

A3 x 1



B1 x 4

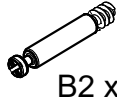

B2 x 4



B4 x 4



G x 2

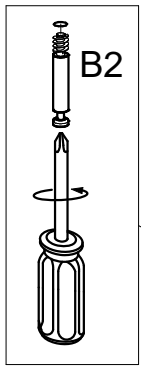
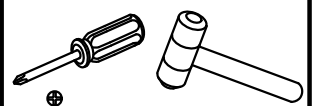

B2

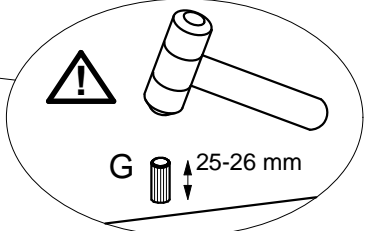
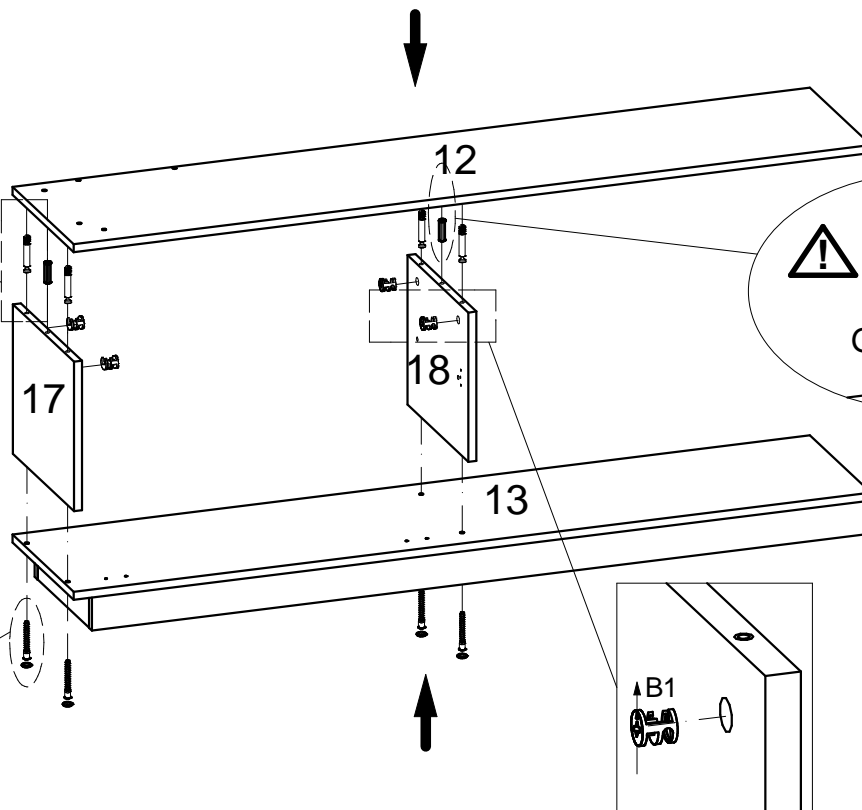

G 25-26 mm

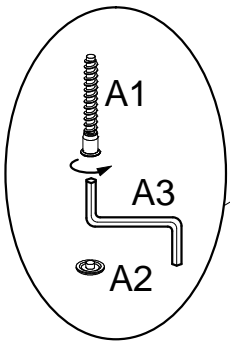

A1

A3

A2

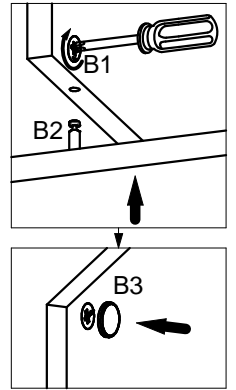

B1

B2

B3

10



A1 x 2



A2 x 2

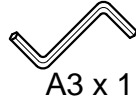

A3 x 1



G x 2

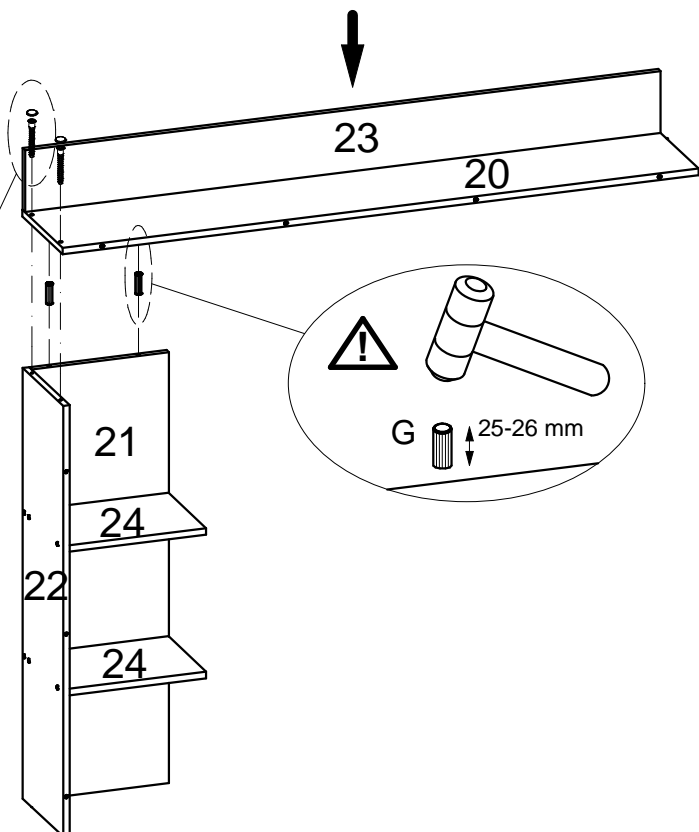
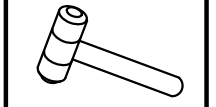

23

20

21

24

22

24

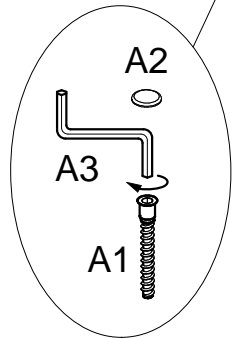

A2

A3

A1

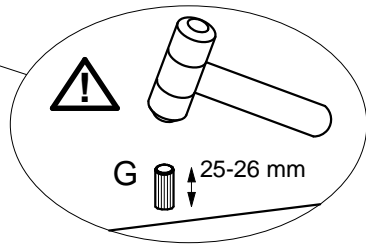

G

25-26 mm

11



B1 x 7

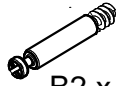

B2 x 7



B3 x 7

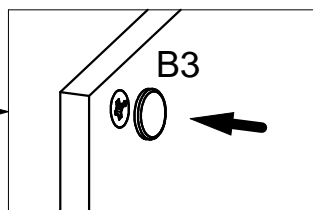
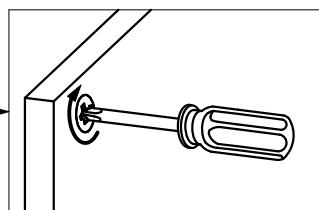
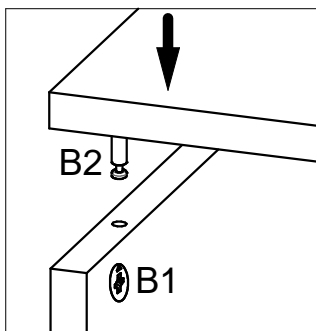
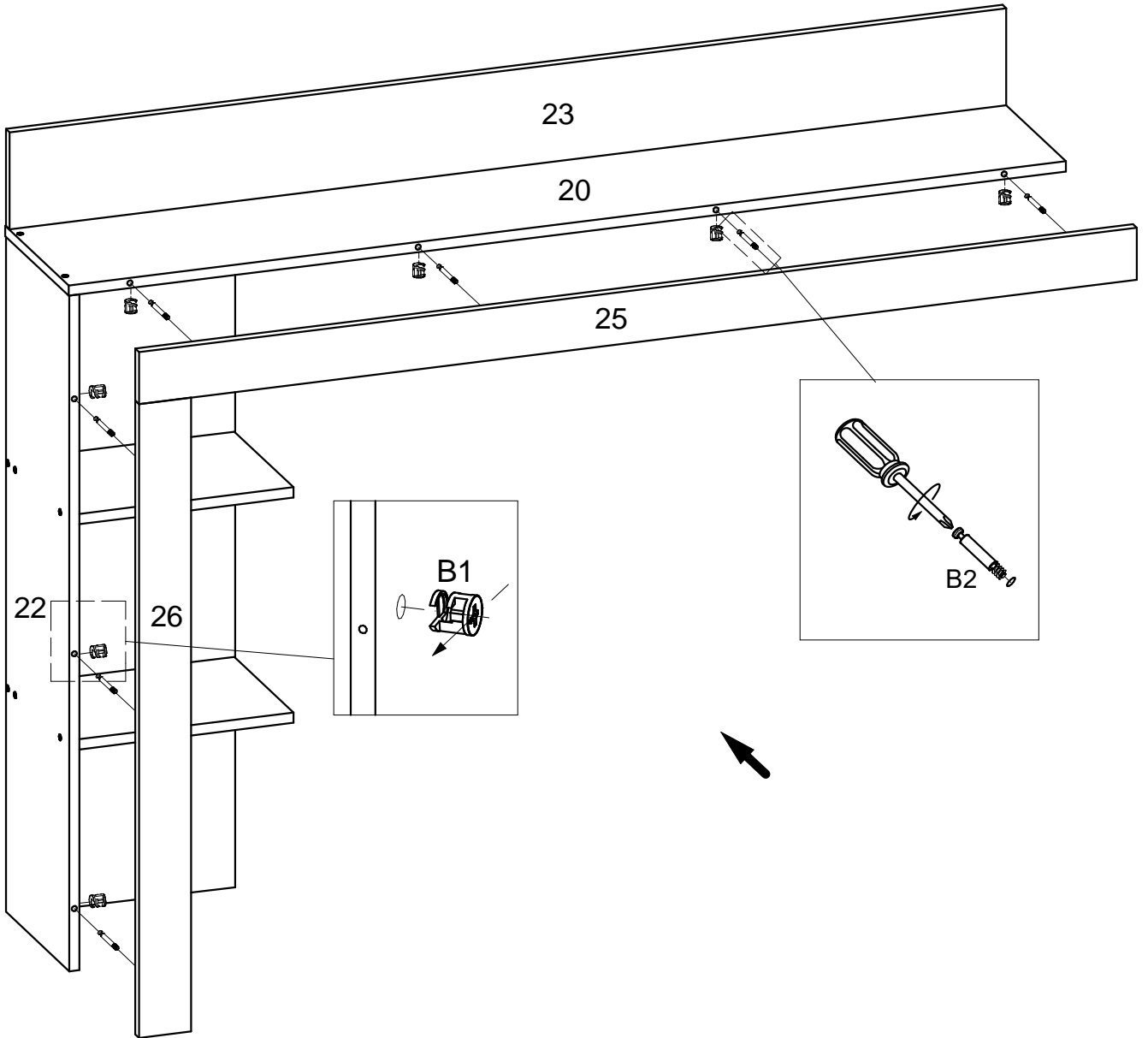
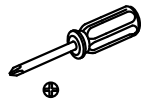

12

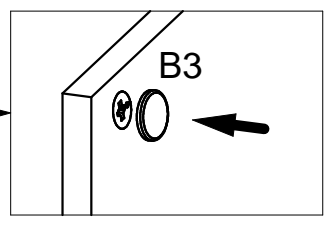
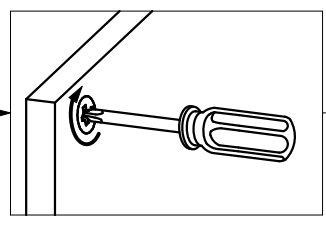
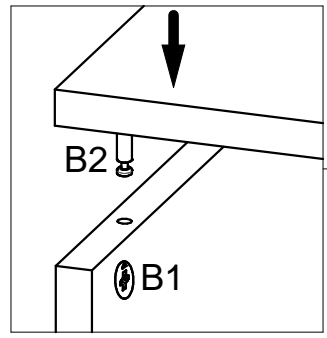
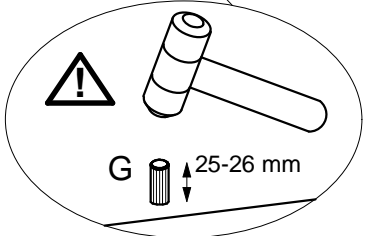
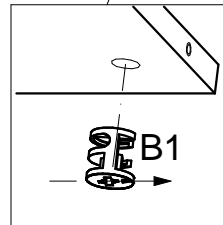
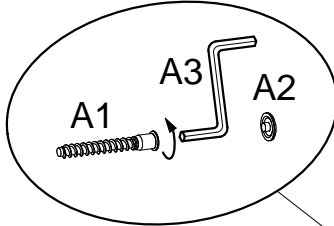
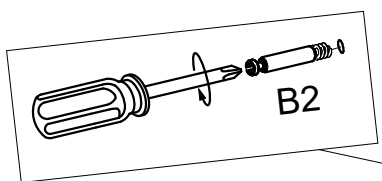
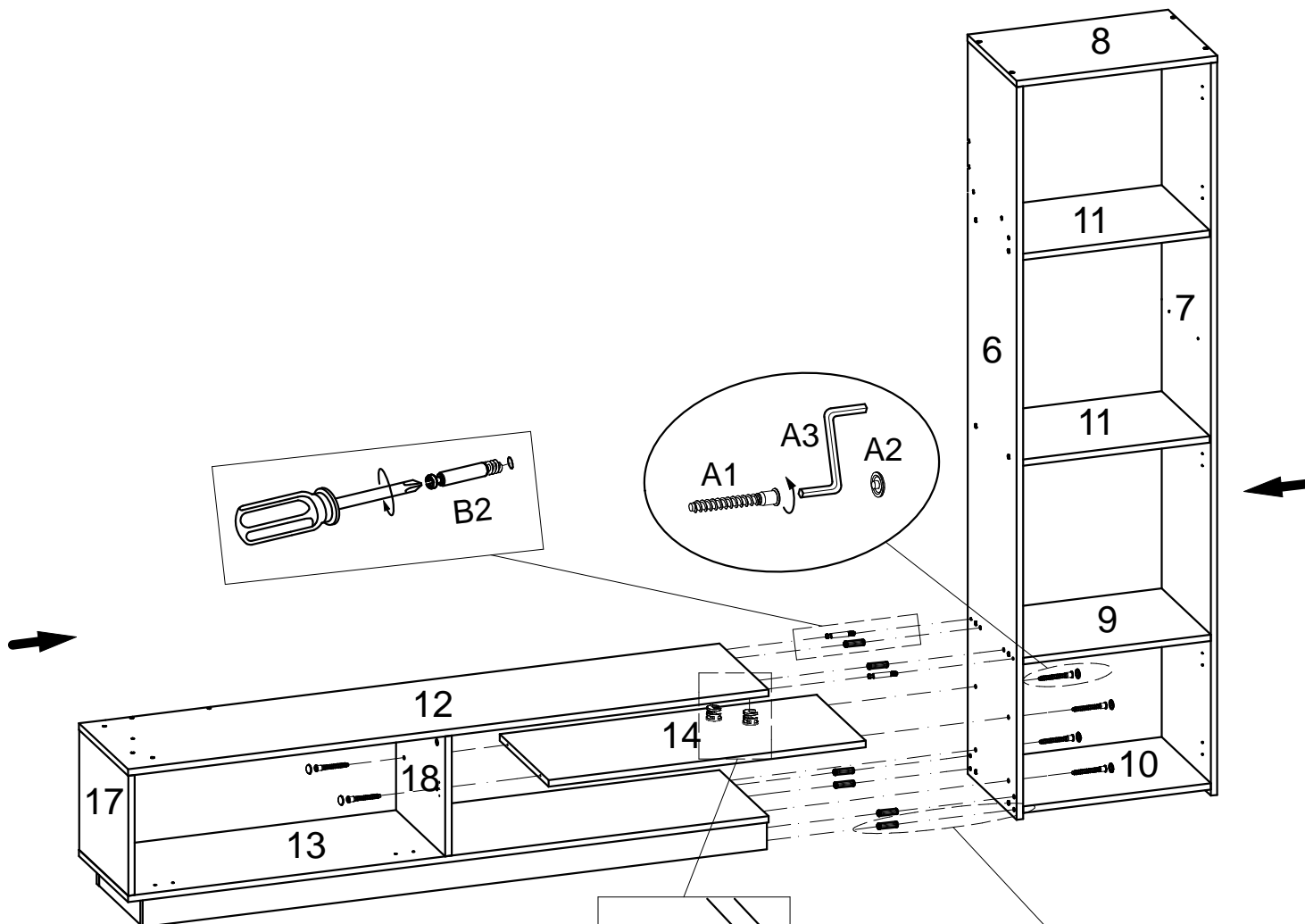
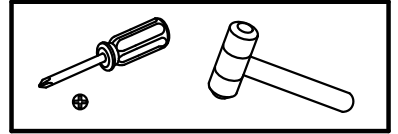
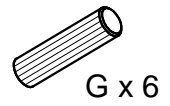
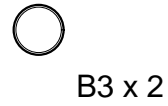
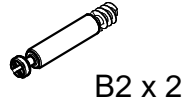
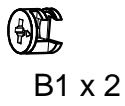
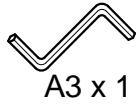
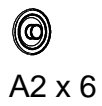
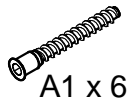

13

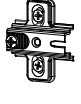
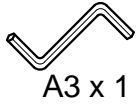

M.1 x 7

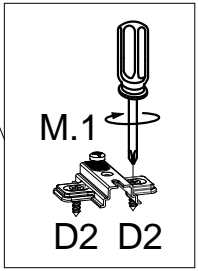
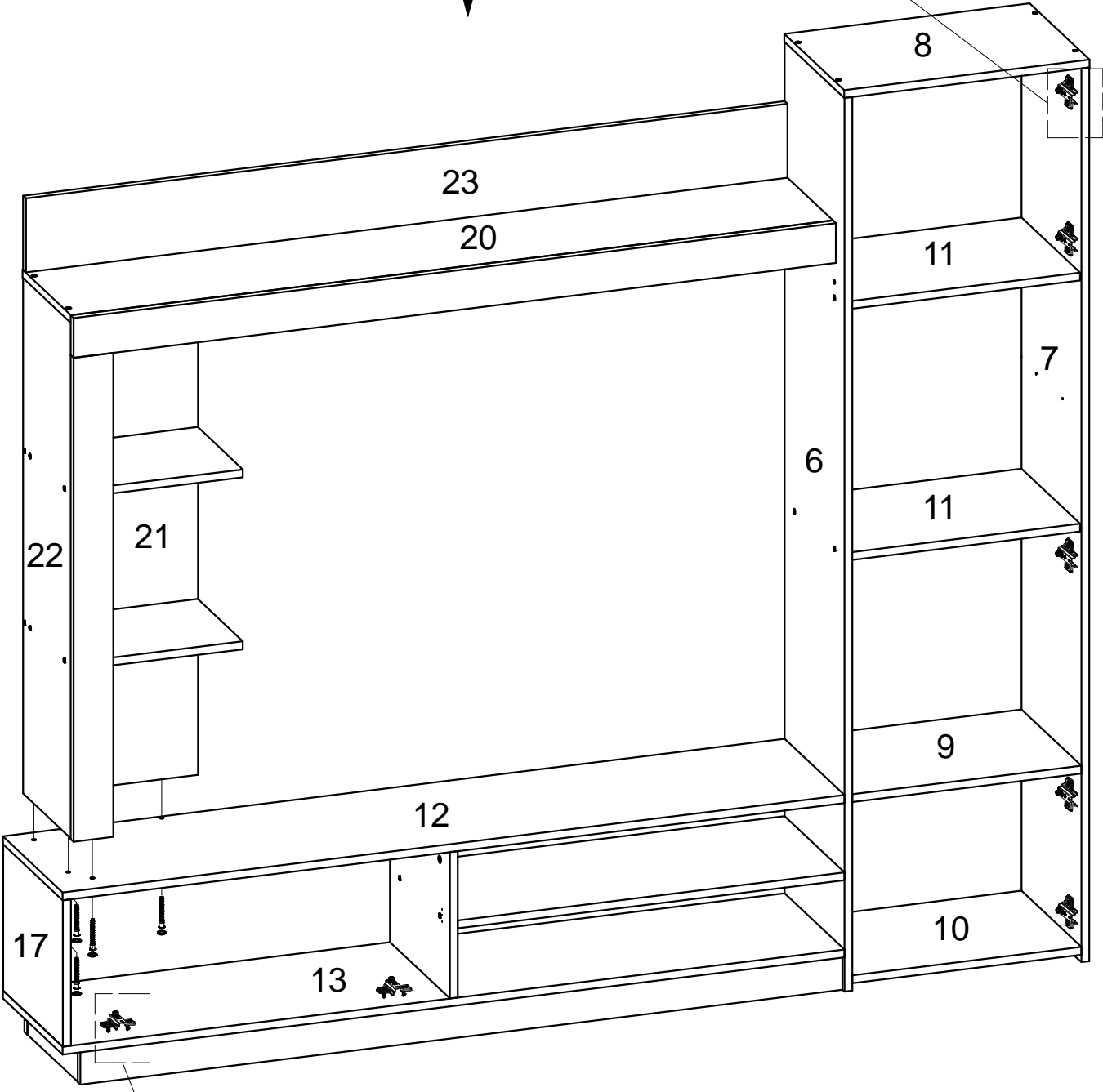
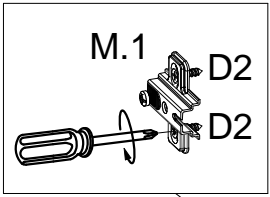
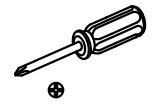

14

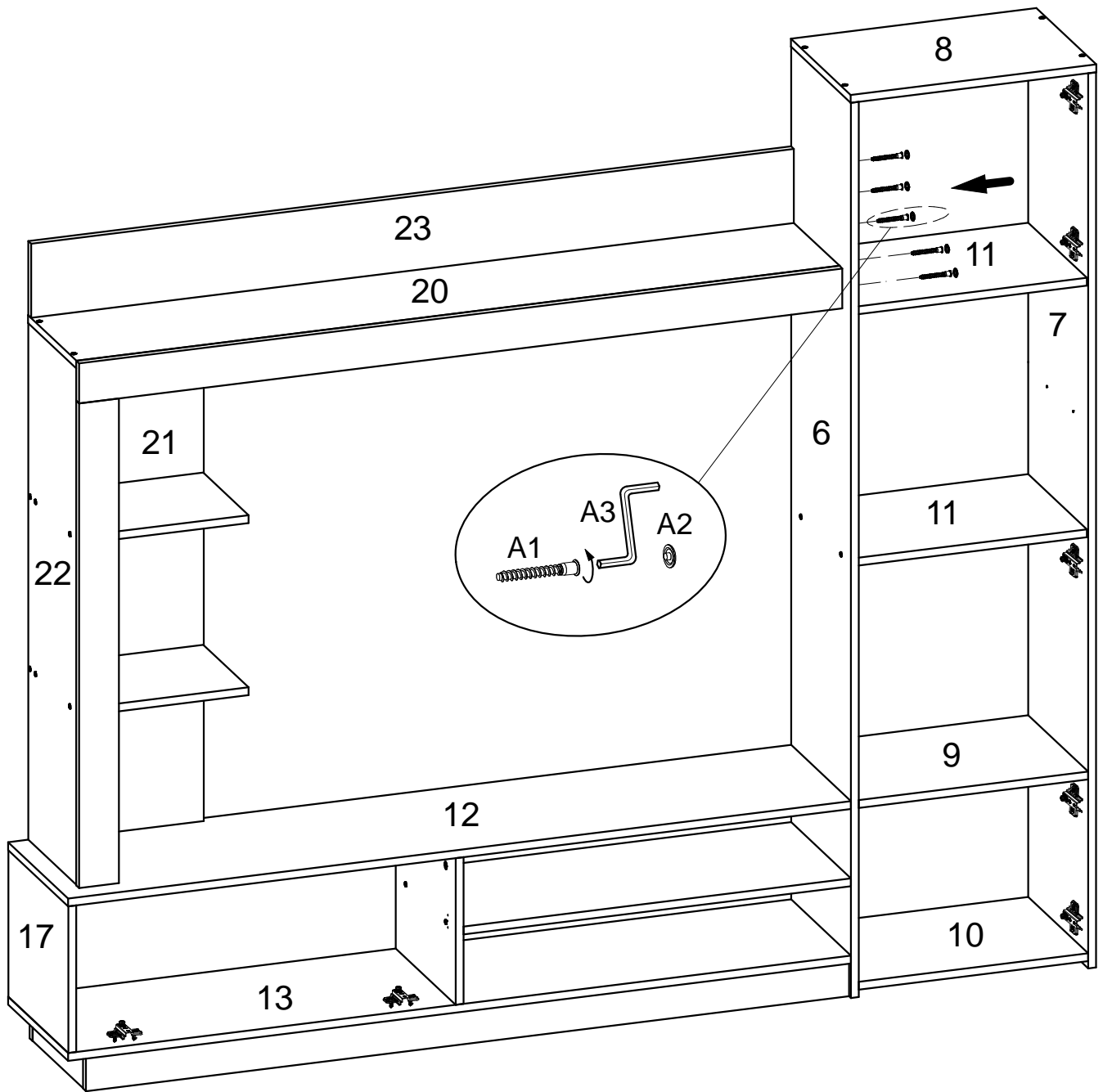
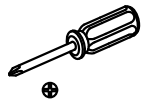
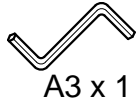
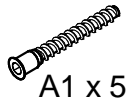

15

D1 x 14

F x 148

Zx14

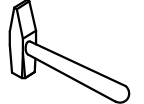
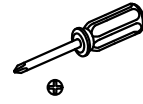

⚠ XX=YY≅90°

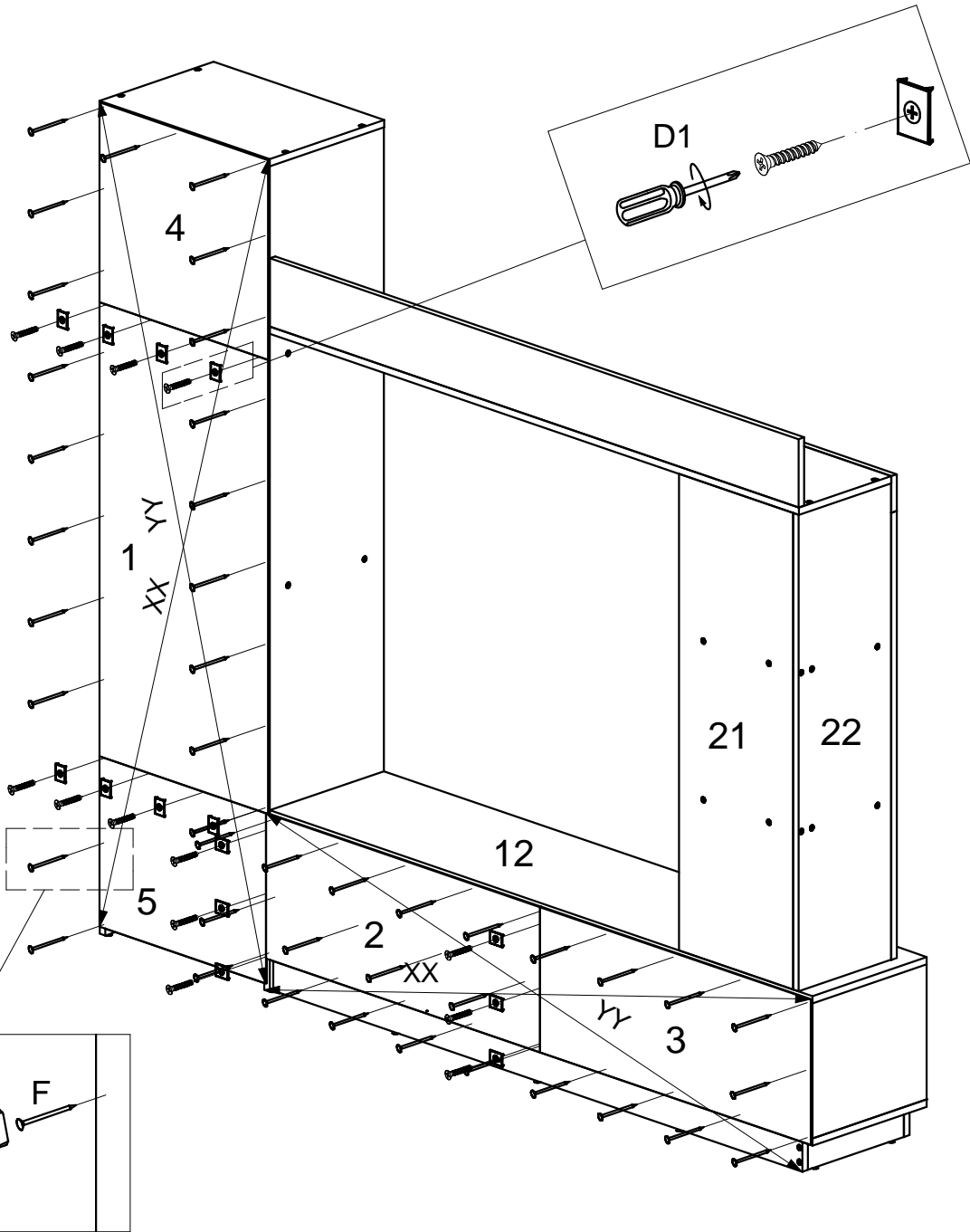

16



C x 8



D2 x 14



D3 x 8



D4 x 12



D5 x 5



H1 x 1



H2 x 1



L x 4

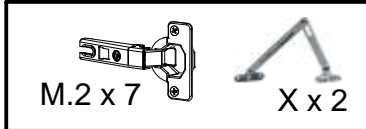

M.2 x 7



X x 2

